

SAVE THESE INSTRUCTIONS

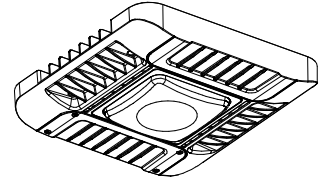

READ THOROUGHLY BEFORE INSTALLATION

WARNING! Fixtures must be grounded and installed in accordance with the National Electrical Code and all local codes. Failure to do so may increase the **RISK OF PERSONAL INJURY, PROPERTY DAMAGE, FIRE AND DEATH**. Install and use so fixture failures do not cause a hazard and use only in environments for which the product is specifically marked.

WARNING! This product contains chemicals known to the State of California to cause cancer, birth defects, and/or other reproductive harm. Thoroughly wash hands after installing, handling, cleaning, or otherwise touching this product.

WARNING! Dangerous voltage exist within the unit and all precautions usually observed in handling high voltage equipment should be observed when replacing light engine or otherwise servicing luminaires. Disregarding this warning could result in electrical shock and possible injury to the individual installing or servicing this equipment. Installation and servicing should be done by qualified personnel.

CAUTION! Follow ALL luminaire recommendations, product markings, instructions, restrictions and warnings regarding luminaire operation and burning position. Luminaire label shows electrical and environmental requirements and restrictions.

NOTE! This luminaire is designed for outdoor lighting applications with ambient temperatures not exceeding 40°C (104°F).

All electrical work must be done by a qualified electrician.

Turn off electric power to all affected circuits and allow to cool before installation or servicing.

A regularly scheduled maintenance program should be established to retain optimum light output and reduce heat retention. Dusting with a soft, clean, dry cloth is normally sufficient for the optical system. Any accumulation of dust or dirt should be removed regularly.

Carefully read these instructions before installing product. If you do not understand these instructions, before starting any work, contact your Hubbell Lighting distributor or techsupport@hubbell-ltg.com or (864) 678-1000

Give instructions to facility owner/manager for future reference.

Mounting The Fixture

Tools Required: **Hardware included:**

- | | |
|-------------|---|
| Power Drill | Self tapping Screws (4 pcs) - M6.3x60mm |
| Drill Bit | Safety wire (1 pc) |
| Drive Bit | Screw for safety wire (1 pc) - M5x6mm |
| | Foam Housing Pads (4 pcs) |

- Turn off power to electrical connections.
- Wiring must be performed by a qualified electrician.
- Make electrical connections according to the local and National Electrical Codes.
- This product is only suitable for Universal Voltage wiring.
- Remove fixture from packaging along with hardware bag.

There are three wires coming out of this fixture:

- Black Wire - Line Voltage
- White Wire - Neutral
- Green Wire - Ground

Connect these wires to the supply wires using the wire nuts provided in the hardware bag. (Fig. 1)

• Ceiling Mount:

- Drill holes or utilize self-drilling screws into ceiling in the pattern shown (you may use the fixture itself as a pattern for the mounting holes) (Fig. 2)
- Attach one side of the safety wire to the fixture and the other side to the ceiling to securely hold the fixture in place during installation (Fig. 3).
- Connect the wires as shown (Fig. 1) and then secure fixture to the ceiling with the screws and washers as shown (Fig. 4).

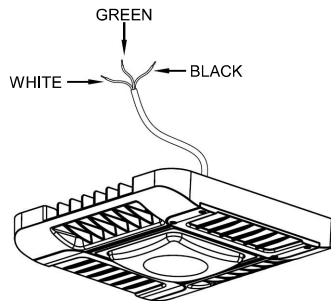

FIGURE 1

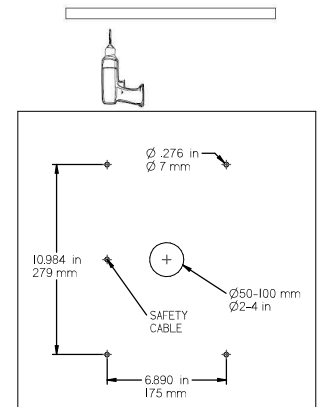

FIGURE 2

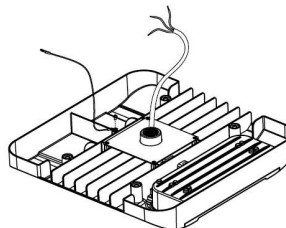

FIGURE 3

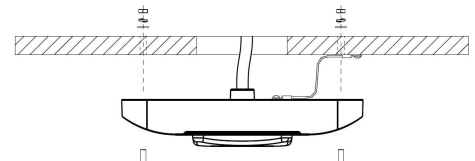

FIGURE 4

93131705 Rev. C

SAVE THESE INSTRUCTIONS

Pendant Mount:

- Attach one side of the safety wire to the fixture and the other side to the ceiling to securely hold the fixture in place during installation (Fig. 3).
- Connect the wires as shown (Fig. 1) and then secure fixture to the ceiling with the 3/4" NPT Pendant (Fig. 5).

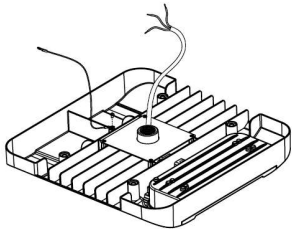

FIGURE 3

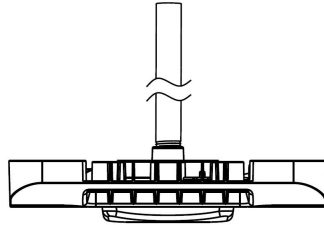

FIGURE 5

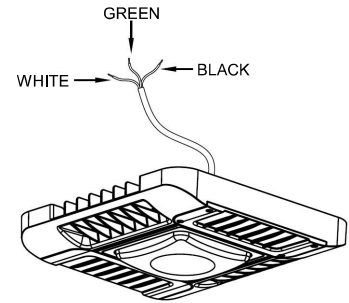

FIGURE 1