

9095 Overfill Prevention Valve Series



2-inch 9095AA



9095AA Aluminum Series - 2"

Item Number	Inlet Size	Tank Connection Size	Drop Tube	Fill Connection	Other Distinctions
9095AA0200 AV	2"	4"	2"	Direct fill	
9095AA3200AVEVR	2"	4"	2"	Remote fill	
9095AA5200AVEVR	2"	4"	2"	Direct fill	Dry disconnect style
9095AA4000 AV	3"	4"	2"	Direct fill	
9095AA4200AVEVR	3"	4"	2"	Remote fill	
9095AA9200AVEVR	2"	4"	2"	---	Without adaptor or bushing *
9095ATM0100 AM	Mechanical test mechanism for 9095AA (does not include valve top)				
9095ATM0200 AK	Mechanical test mechanism; includes AA 0200 top, aluminum with 2" male quick disconnect x 4" female threads				
9095ATM3200 AK	Mechanical test mechanism; includes AA 3200 top, ductile iron with 2" female threaded x 4" female threaded connection				

*Order top connections separately.

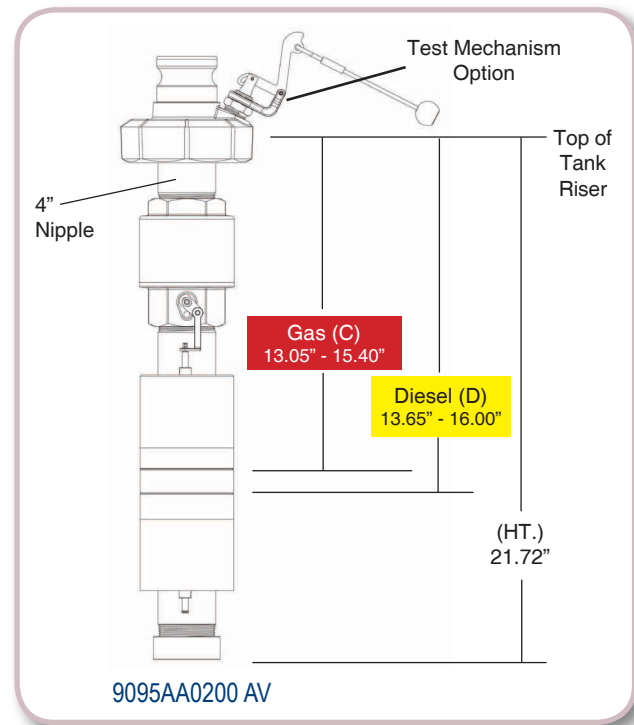
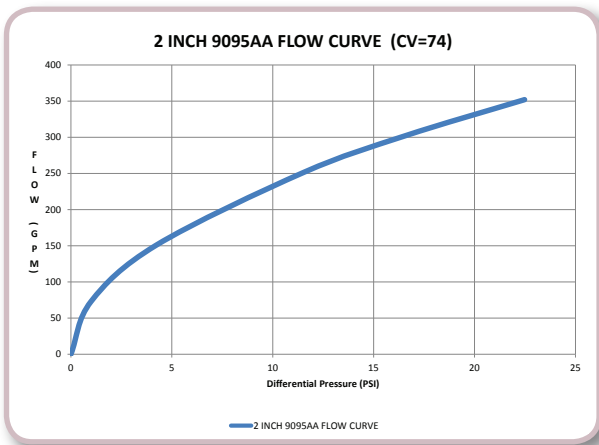

3-inch 9095AA

9095AA Aluminum Series - 3"

Item Number	Inlet Size	Tank Connection Size	Drop Tube	Fill Connection	Other Distinctions
9095AA0300 AV	3"	6"	3"	Direct fill	
9095AA3300AVEVR	3"	6"	3"	Remote fill	
9095AA9300AVEVR	3"	6"	3"	---	Without adaptor or bushing *
9095ATM0100 AM	Mechanical test mechanism for 9095AA (does not include valve top)				
9095ATM0300 AK	Mechanical test mechanism; includes AA 0300 top, aluminum with 3" male quick disconnect x 6" female threads				
9095ATM3300 AK	Mechanical test mechanism; includes AA 3300 top, ductile iron with 3" female threaded x 6" female threaded connection				

*Order top connections separately.

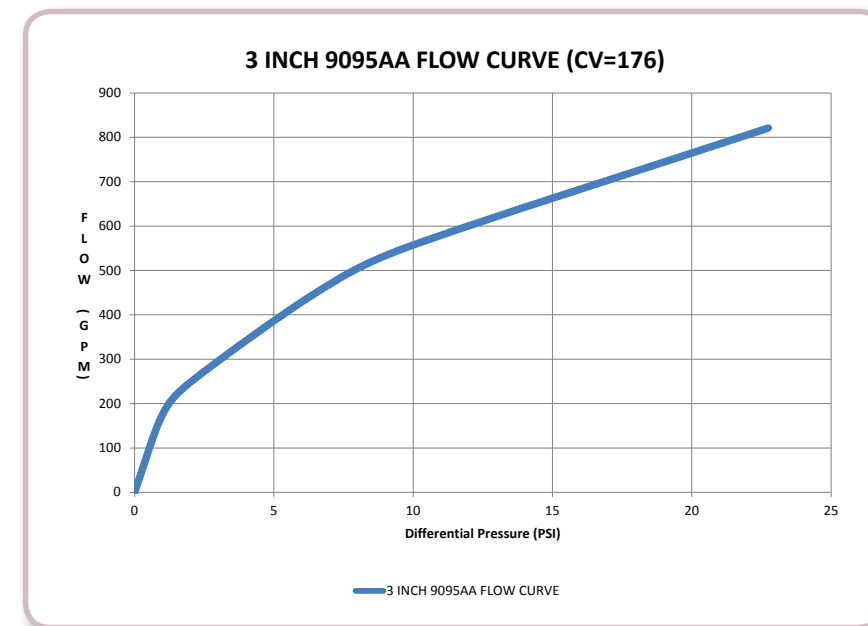

2-inch 9095X

9095X Aluminum, Integrated Adaptor Series - 2"

Item Number	Inlet Size	Tank Connection Size	Drop Tube	Fill Connection	Application
9095X-1100 AV	2"	4"	No	Direct fill	Generator base tanks with integrated spill container
9095X-6100 AV	2"	4"	No	Remote fill	Generator base tanks with integrated spill container
9095X-2200 AV	2"	4"	2"	Direct fill	Low profile tanks; integrated spill container
9095X-6200AVEVR	2"	4"	2"	Remote fill	Low profile tanks; integrated spill container
9095X-2800 AV	2"	4"	2"	Direct fill	General purpose and aviation
9095X-6800AVEVR	2"	4"	2"	Remote fill	General purpose and aviation
9095ATM1000 AK					Mechanical Test Mechanism Kit For All 9095X Series (X only) Overfill Valves

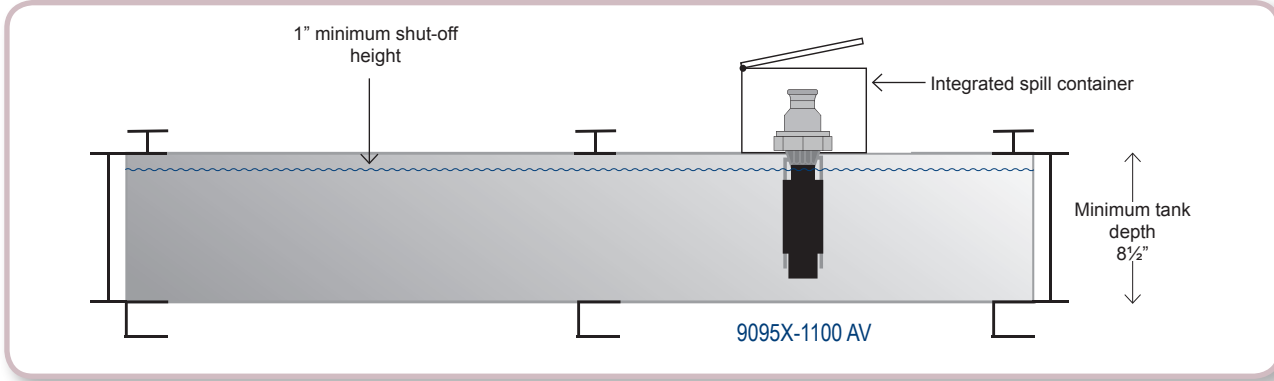
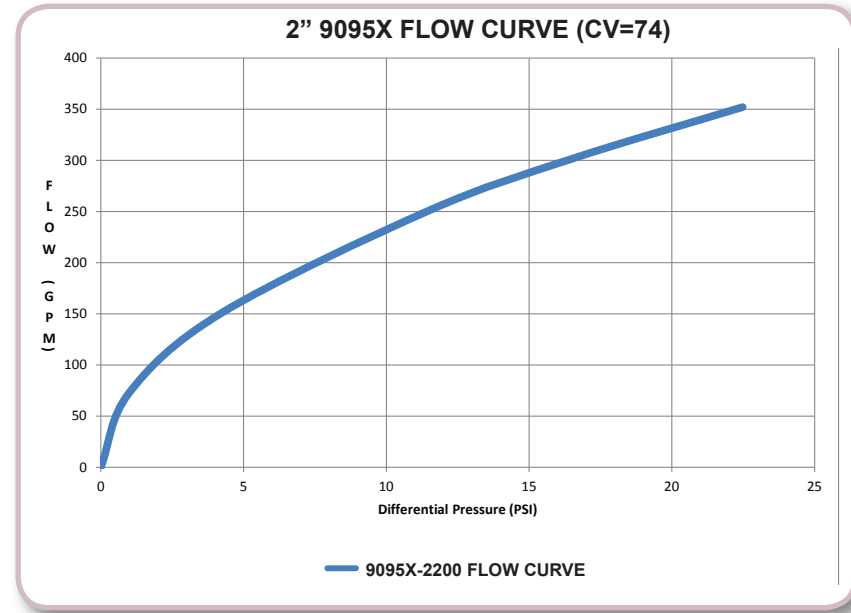

Shut-off Ranges

MORRISON BROS. CO.

9095X Overfill Prevention Valve Selection Guide

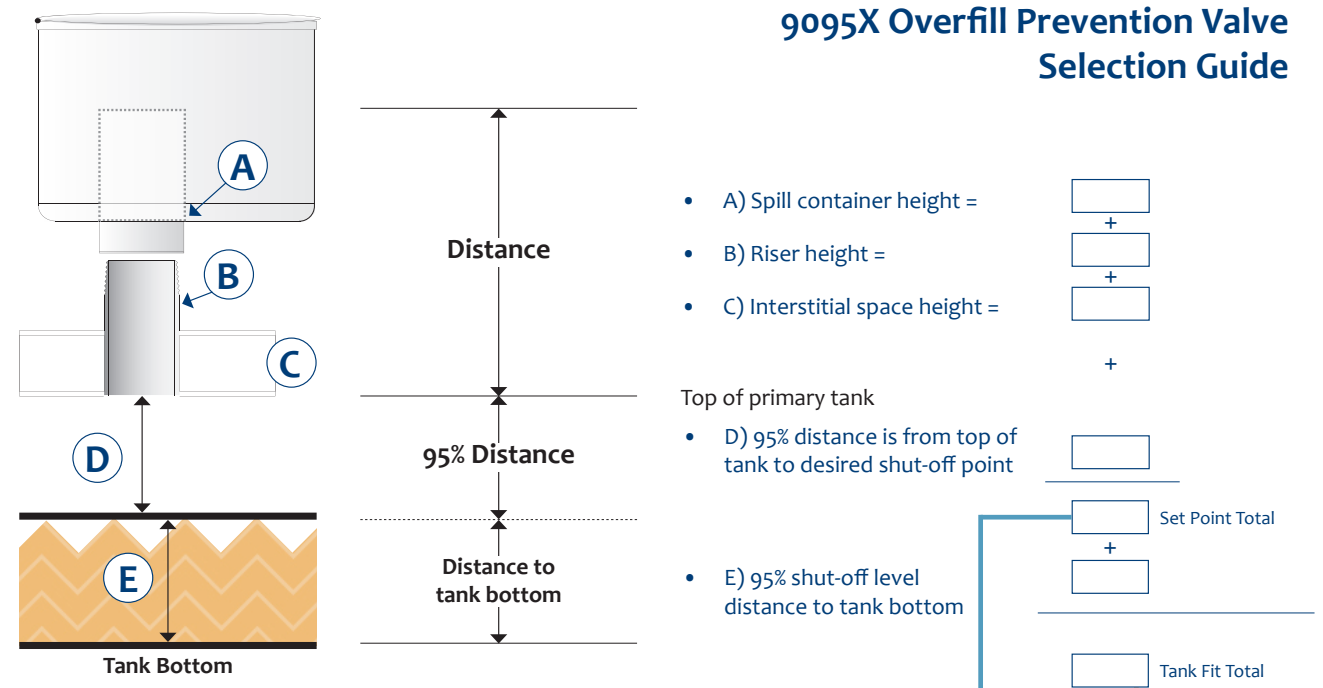

- A) Spill container height =
 - B) Riser height =
 - C) Interstitial space height =
 - Top of primary tank
 - D) 95% distance is from top of tank to desired shut-off point
 - E) 95% shut-off level distance to tank bottom
- Set Point Total
- Tank Fit Total

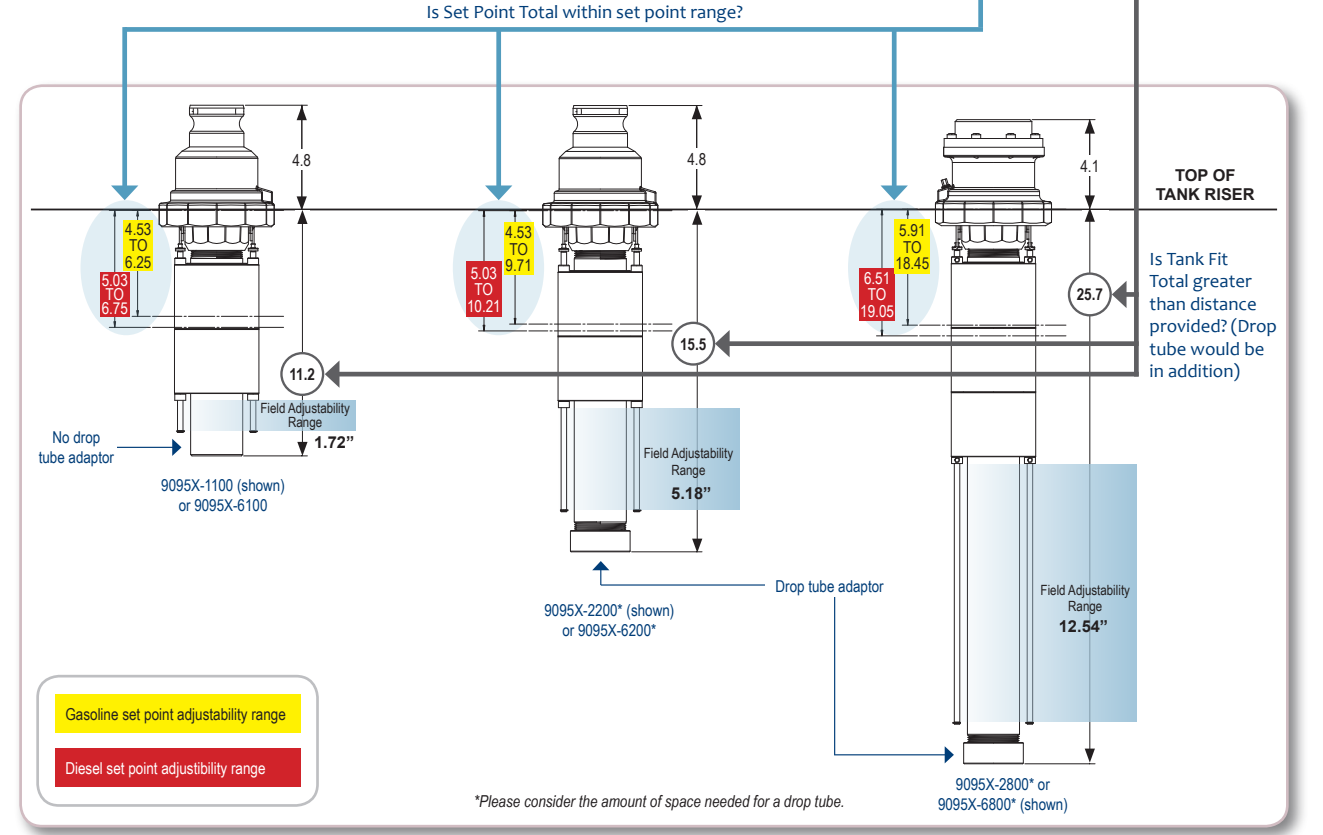

2-inch 9095SA



9095SA (Aluminum) Series - 2"

SA Model Number	Inlet Size	Tank Connection Size	Fill Connection	Drop Tube	Other Distinctions
9095SA0200 AV	2"	2"	Direct fill	No	Cam-n-groove adaptor style with male threads
9095SA0500 AV	2"	2"	Remote fill	No	Cam-n-groove adaptor style with female threads
9095SA9200 AV	2"	2"		No	Without adaptor *

*Order top connections separately.

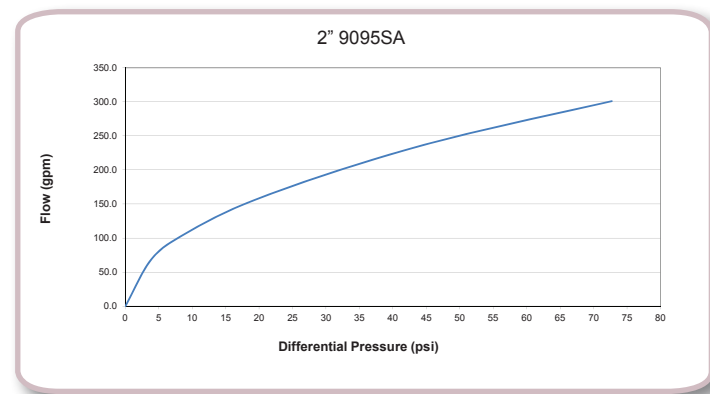

Additional Overfill Prevention Valves

9095AM (Methanol, 2" Fill, 4" or 6" Connection)

Item Number	Valve Size	Tank Opening	Drop Tube	Fill Connection	Weight (lbs)
9095AM3200 AV	2"	4"	2" threaded pipe	Remote fill	14.10
9095AM3300 AV	3"	6"	3" threaded pipe	Remote fill	30.0



9095DS (2" Fill, 2" Connection)

Item Number	Valve Size	Tank Opening	Drop Tube	Inlet Size & Type	Weight (lbs)
9095DS0200 AV	2"	2"	1½" threaded pipe	Valve with 2" shut-off height	8.50
9095DS0400 AV	2"	2"	1½" threaded pipe	Valve with 4" shut-off height	9.0
9095DS0600 AV	2"	2"	1½" threaded pipe	Valve with 6" shut-off height	9.50
9095DS2200 AV	2"	2"	1½" threaded pipe	Valve with 2" shut-off height	8.50
9095DS2400 AV	2"	2"	1½" threaded pipe	Valve with 4" shut-off height	9.0
9095DS2600 AV	2"	2"	1½" threaded pipe	Valve with 6" shut-off height	9.50

*Consult Price List for BSP options.



9095SS (Stainless, 2" Fill, 2" Connection, No Drop Tube)

Item Number	Description	Weight (lbs)
9095SS0200 AV	2" SS Overfill prevention valve, 2" to 16" with Part F male threads	8.20
9095SS0400 AV	2" SS Overfill prevention valve, 2" to 28" with Part F male threads	8.20
9095SS0600 AV	2" SS Overfill prevention valve, 2" to 76" with Part F male threads	8.20
9095SS2200 AV	2" SS Overfill prevention valve, 2" to 16" with Part A female threads	8.20
9095SS2400 AV	2" SS Overfill prevention valve, 2" to 28" with Part A female threads	8.20
9095SS2600 AV	2" SS Overfill prevention valve, 2" to 76" with Part A female threads	8.20
9095SS9200 AV	2" SS Overfill prevention valve, 2" to 16" without adaptor	7.50
9095SS9400 AV	2" SS Overfill prevention valve, 2" to 28" without adaptor	7.50
9095SS9600 AV	2" SS Overfill prevention valve, 2" to 76" without adaptor	7.50
9095SS9800 AV	2" SS Overfill prevention valve, 2" to 96" without adaptor	

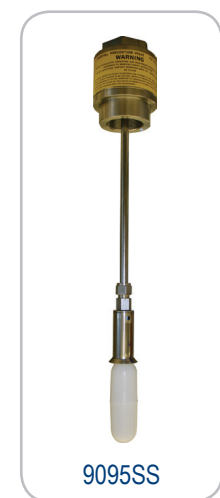

9095 Series Selection Guide



Model Series #	Tank Opening			Tight Fill Connection		Dry Disconnect Connection	Remote Fill Connection	Drop Tube Size			ULC Listed	CARB EVR Approved	Low Profile Tank	Fuel Compatibility					GPM Flow @ 10 PSI Pressure Drop	
	2"	4"	6"	2"	3"			1½"	2"	3"				Aviation	E-85	DEF	B100	Methanol		
9095AA	✓			✓	✓	✓	✓	✓			✓	✓*		✓	✓		✓		230	
9095AA			✓		✓		✓			✓	✓	✓*		✓	✓		✓		550	
9095C	✓			✓		✓	✓	✓			✓	✓	✓		✓			✓		175
9095C-A	✓			✓		✓	✓	✓			✓	✓	✓	✓	✓			✓		175
9095AM	✓						✓	✓†		✓				✓	✓			✓	✓	230
9095AM			✓				✓	✓†		✓				✓	✓			✓	✓	550
9095DS	✓			✓				✓†					✓							26
9095X	✓			✓			✓	✓		✓	✓*	✓	✓	✓	✓			✓		230
9095SA	✓			✓			✓			✓			✓					✓		110
9095SS	✓			✓									✓			✓	✓			164

MORRISON BROS. CO.

570 E. 7th Street, P.O. Box 238 | Dubuque, IA 52004-0238
 t. 563.583.5701 | 800.553.4840 | f. 563.583.5028
 custserv@morbros.com | www.morbros.com